

# 6209

**ORDERING CODE**

**420202XXXX**

**APPLICATION**

TIPPER  
 WATE BOWSER  
 RECOVERY VEHICLE  
 LIFTING PLATFORM

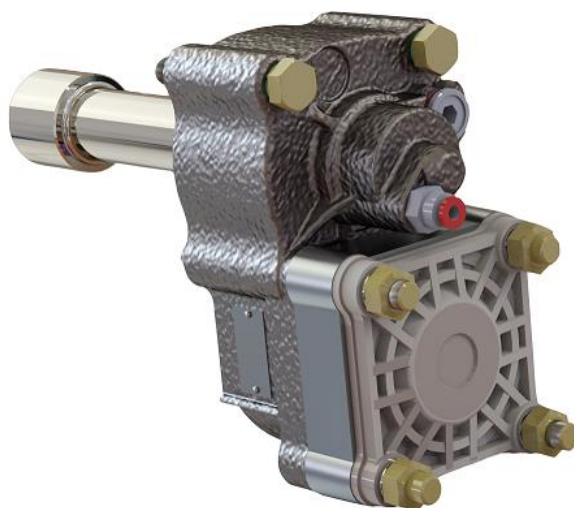

**TECHNICAL SPECIFICATION**

GEAR BOX TYPE	EATON 6209
TORQUE	300 NM
ROTATION DIRECTION	ENGINE DIRECTION
ENGAGEMENT TYPE	PNEUMATIC
PTO INTERNAL RATIO	1.32
WEIGHT	8.7 kg
DURATION OF OPERATION	5min (max)
OPTIONS	PUMP 4BOLT - 43,57,65 FLANGE SPICER 1300

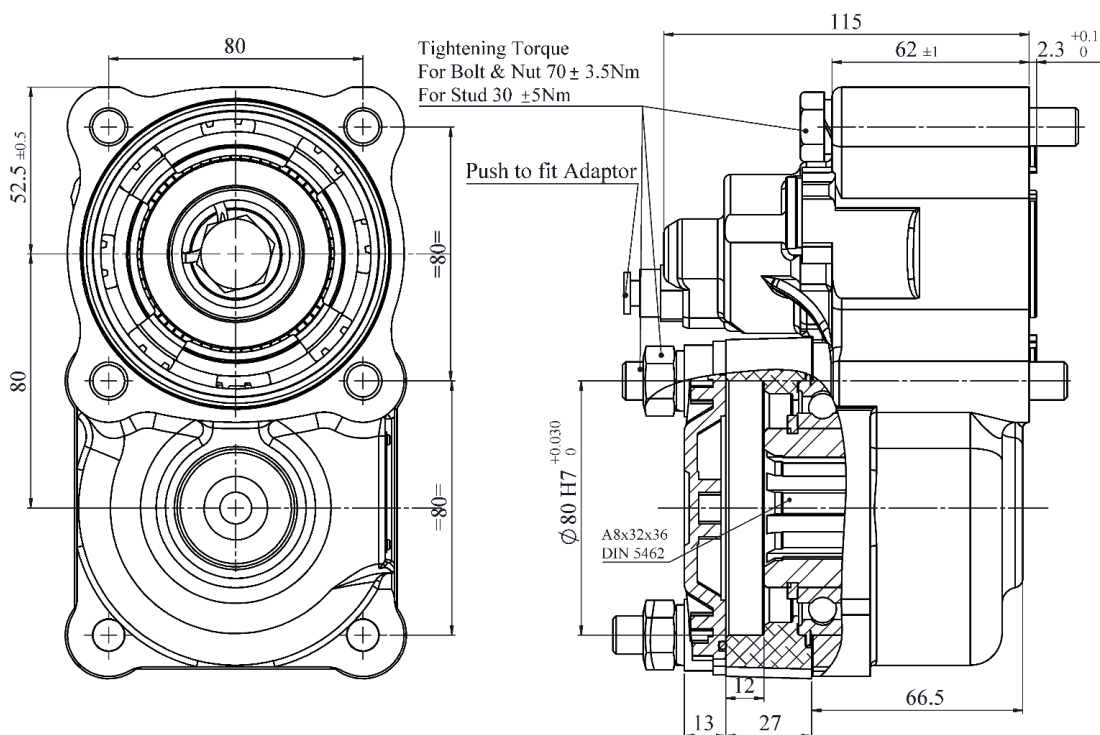

PTO WITH PUMP, PTO WITH FLANGE COMBINATION WILL BE SUPPLIED AS PER CUSTOMER REQUIREMENT

IPH reserves the right to modify the technical data mentioned into this catalogue without notice.  
 The herewith mentioned data are not bounding.